

BASE VEHICLE

BASE VEHICLE FEATURES

Vehicle	<i>Fiat Ducato X250</i>
Version	L2H2 Multijet 16V 6 gear compact windowed van EURO 6 D FINAL
Colour	<i>White</i>
Seats in driver's cab	<i>2 (TWO)</i>

BASE VEHICLE AND ACCESSORIES

Code

	3.5 TON LOAD CAPACITY - MANUAL GEARBOX - 6 GIFTS	
*	35 MH2 2.2 Multijet 16V 140 HP GLAZED VAN	
		<i>Vehicle Total</i>



PRICES OF OPTIONS SUPPLIED		Code
Increased power battery 110 Ah		
Front manual controlled air conditioning		
Oil level gauge		
Single co driver seat		
Servotronic - Power steering with variable control		
Parking sensors		
90 liters capacity tank		
Armrest and lumbar support for driver's seat		
ASR		
Adjustable height driver seat		
ABS with EBD		
Electric windows		
Driver side Airbag		
Centralised locking with remote key control		
Power steering		
15" STEEL WHEELS		
ARMREST ON DRIVING SEAT		
90 liter FUEL TANK		
BACK ELECTRICAL MIRRORS WITH INTEGRATED HEATING SYSTEM		
BACK SENSORS		
THERMIC BACK WINDW IN BACK DOORS		
PRIVACY GLASSES PASSENGER AREA		
CONVERTERS GATE AND SECOND BATTERY PRE-SET		
SINGLE CO-DRIVER SEAT WITH REGULATION + ARMREST		
ARRANGEMENT FOR CLIMATE SYSTEM AND HEATING SYSTEM		
BACK VIEW CAMERA		
SLIDING WINDOWS IN SECOND RAW		
EMERGENCY WHEEL FIXED UNDER FLOOR IN THE BACK + FIX AND GO KIT		
SINGLE AIRBAG FOR CO-DRIVER SIDE		
TECHNO PACK: 7" Radionav Display Touch Bluetooth + DAB + CP/AA Double USB charging port on dashboard Automatic Air Conditioning		



ASSIST PACK: Autonomus Emergency Brake Control With Pedestrian And Cyclist Detetion Lane Control (Lane Support System) Rain and Twilight Sensor Traffic Sign Recognition + high Beam Recognition)	
HANDS FREE PACK: Smartphone wireless charger Leather steering wheel and shift lever knob Electric parking brake keyless	
LOOK 1 PACK: Drl led Fog lamps with turn indicator lights Integral wheel cups	
CITY PACK: Electrically folding exterior mirrors Rear view camera	
AMBULANCE PACK: Transformer socket and battery pre-set M+S Tires Front and rear mudflaps kit Rear climate prearrangement Traction+ with hill descent control	
TRACTION PLUS PACK	
SECURITY PACK "Dead locking" safety locks Perimeter burglar alarm	

1. AMBULANCE EXTERIOR

1.1 SUPPORTS FOR SIGNALLING DEVICES	Qty	Specifications/Notes
		
<p>Basic white lower traditional front spoiler. Made of fiberglass and not protruding from the outline of the vehicle. Possibility to install:</p> <ul style="list-style-type: none"> ▪ Pair of flashing beacons / Light bar ▪ Speakers and siren ▪ Rotating light beacon <p>* </p>	1	
<p>Basic white lower traditional rear spoiler. Made of fiberglass and not protruding from the outline of the vehicle. Possibility to install:</p> <ul style="list-style-type: none"> ▪ Pair of flashing beacons ▪ No. 2 orange round led lights ▪ No. 2 white round led lights ▪ Third Stop Light <p>* The spoiler is equipped with access door to the sanitary compartment evaporator unit for air conditioning maintenance work</p>	1	

1.2 VISUAL INDICATORS - EXTERNAL LIGHTING		Qty	Specifications/Notes
SIGNAL LIGHT FRONT			
*	Pair of front flashing lights with strobe-effect LED lights, Intav LCS Ledflex with cruise lights	1	
*	LED swinging searchlight with electric control mod. Intav Omnilux	1	
SIGNAL LIGHT BACK			
*	Pair of rear flashing lights with strobe-effect LED lights, Intav LCS Ledflex with cruise lights	1	
*	Pair of orange led rear emergency lights , blinking, synchronised with the opening of the rear doors.	1	Synchronous activation system with turn indicators
*	Pair of white led rear illumination lights , synchronized with the opening of the rear doors	1	System for self-activation when reverse gear is engaged
*	Manual disconnection of the Rear Spoiler Light.	1	

1.3 HORNS		Qty	Specifications/Notes
*	Reverse signaling device for moving ambulance (buzzer)	1	
*	Reverse beeper disconnection via pushbutton on control panel.	1	
*	Electronic two-tone siren mod. HT 100 with double loudspeaker and related control unit. Power 100W. Installed on the roof.	1	<i>Specify: two-tone/three-tone</i>

1.4 MECHANIZATIONS		Qty	Specifications/Notes
*	Rear bumper cover by means of aluminum rice grain sheet, with rubber profiles on the outside, to protect stretcher loading/unloading operations	1	
*	Reduced-thickness mechanical side step with the following features: <ul style="list-style-type: none"> ▪ Synchronous with sliding door by mechanical linkage ▪ Aluminum almond pattern non-slip surface ▪ Rounded side edges ▪ Galvanized metal structure protected by cataphoresis ▪ Useful platform dimensions: 1150 x 270 x 70 mm ▪ Maximum distributed weight load capacity: 200 Kg 	1	

1.5 DECORATIONS, COLORING PATTERN, BRANDING AND MATTING		Qty	Specifications/Notes
*	Public Assistance base decoration consisting of: <ul style="list-style-type: none"> ▪ ECNALUBMA mirror lettering applied to the front hood ▪ Reflective perimeter band made of 3M adhesive paper in orange color and height 20cm ▪ Band applied on the inside of the rear doors made of orange 	1	ALTERNATIVELY, DECORATION COMPLYING WITH "ITALIAN RED CROSS"

	<p>color reflective paper height 20cm</p> <ul style="list-style-type: none"> ▪ Additional band at the top of the vehicle ▪ No. 5 international rescue symbols (Aesculapian staff medicine cross) ▪ Basic name of the association and/or entity ▪ Matting of sanitary compartment glazing at 3/4 height by application of adhesive film 		
--	--	--	--



2. DRIVER'S CAB

2.1 TRANSFORMATIONS, HOUSINGS AND COMPARTMENTS	Qty	Specifications/Notes
<p>Fitting of dashboard made of thermoformed plastic material (ABS), for housing the front control panel, in the central part of the dashboard</p> <p>*</p> 	-	
<p>Radio stand for No. 1 RT radio device made of thermoformed plastic material (ABS), shaped and placed in the central part under the dashboard</p> <p>*</p>	1	

2.2 PLANT AND EQUIPMENT		Qty	Specifications/Notes
<p>Front control panel housed in the driver's cab with 7" color touch screen panel combined with mechanical push button panel for main services. New concept panel with BACK-UP function. Innovative system that allows you to view and control the rear panel services, normally accessible only from the sanitary compartment</p> <p>This function reaches its maximum application in case of failure of one of the control panels</p> <p>The front panel controls the following services:</p> <ul style="list-style-type: none"> - system on/off - main and secondary siren - siren to horn switch - upper and front visibility aids - cruise lights - electric door in partition wall - inverter 12/220V <p>* <ul style="list-style-type: none"> - reverse buzzer cutoff - side step cutoff - sanitary compartment speaker cutoff - right side lights - left side lights - sanitary compartment air conditioner - urgency (simultaneous activation of several devices) - ignition by second battery - air suspension control <p>Large display (4,3 inches) suitable for displaying the following functions:</p> <ul style="list-style-type: none"> - all services - Step return light - sanitary compartment doors open indicator light - 220V mains light on - Engine pre-heater light - outdoor temperature </p>	1		
<p>MAGLITE LED outdoor searchlight, complete with yellow cone and charging base</p>	1	-	

3. AMBULANCE SANITARY COMPARTMENT

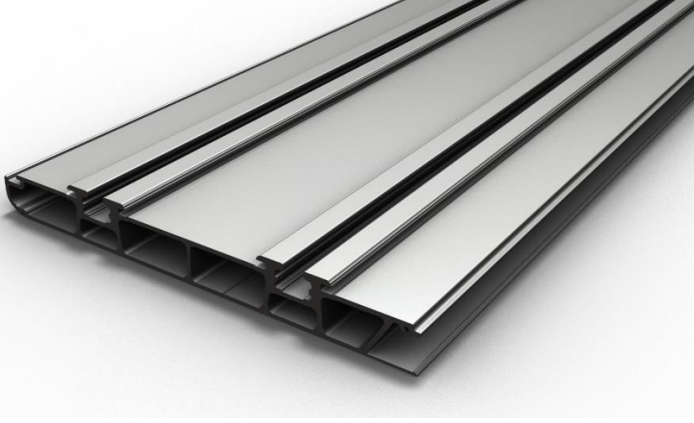
3.1 STRUCTURAL TRANSFORMATIONS		Qty	Specifications/Notes
<p>* Fitting of the load-bearing frame of the outfitting by screwing to the original holes in the vehicle and bonding by structural glue of specially made carpentry elements. This processing technique helps maintain the elasticity of the vehicle's load-bearing frame, eliminating inside vibration and noise.</p>	-		
<p>* Complete insulation of the sanitary compartment by fitting of panels made of sound-absorbing, heat-insulating and fireproofing material (thickness 50mm).</p>	-		

*	<p>Sanitary compartment flooring made by aluminium floor with integrated rails, non-slip, nonabsorbent, porosity-free, and watertight. Washable with running water, resistant to major detergents. Special profile edge flush with the plane to prevent cracking, tested following European standard for seats and steacher holder</p> 	
*	<p>Fitting at the rear and side profiles of the flatbed of non-slip, rice grain aluminum door sills, designed to prevent wear and tear of the floor at the up/down points, most subject to wear and tear</p> <p>Light side door sill</p>	
*	<p>Rear bumper cover by means of aluminum rice grain sheet, aluminum sheet and rubber profiles to protect the loading/unloading area of the stretcher</p>	

3.2 STANDARD FINISH COATINGS		Qty	Specifications/Notes
*	<p>Internal coating of the sanitary compartment in thermoformed high cleanable ABS/ASA plastic material and polyurethane inserts. CE certified, self-extinguishing, recyclable, odorless, perfectly hygienic, with modular structure and with parts individually replaceable in case of breakage. All cladding structures</p>	-	<p>Available colors:</p> <ul style="list-style-type: none"> ▪ White / Silver

	are rounded, shaped and free of sharp edges.		
*	Upholstery of seats, armchairs and inserts made of class 1 material, self-extinguishing, certified, perfectly cleanable and disinfectable.	-	Silver color

3.3 UNDER-ROOF PAVILION - INTERNAL LIGHTING	Qty	Specifications/Notes
---	-----	----------------------

*	<p>Highly cleanable roof pavilion made of ABS/ASA thermoformed plastic material. Composed of:</p> <ul style="list-style-type: none"> ▪ N. 2 ceiling lights with 10 steps white led lights for diffused illumination, adjustable from the front and rear touch-screen display with the option "night" with blue lights ▪ N. 4 spot lights, with high intensity triple led lamp ▪ N. 2 suction grids for the air recirculation of the sanitary compartment allow for the air change every 3 minutes ▪ N. 1 aerator for air intake and extraction positioned at the front ▪ N. 14 air conditioning points distributed on the long sides of the pavilion ▪ N. 2 longitudinal grab handles, not emerging from the tunnel, made of soft anti-slip rubber with steel core ▪ N. 2 supports for infusion bags ▪ N. 2 new design IV stands that support any type of IV with built-in system without hooks 	-	
---	---	---	---

NIGHT LIGHT

DAY LIGHT



FURNITURE (Upper part)



Wall cabinet (L = 50 cm) housed in the left wall closed to the bulkhead. Made of white thermoformed high cleanable ABS/ASA plastic material, with lower containment edge, completely rounded and shock absorbing. Doors with **"Easy Push"** opening system. Internally lit with integrated ceiling led lights. Integrated bottle holder with elastic bands.

*



1



Wall cabinet (L = 130 cm) located in the under-roof on the left wall, after the console. Made of white thermoformed high cleanable plastic ABS /ASA, with lower containment edge with windows in transparent plexiglass, completely rounded and shock-absorbing. Doors with **"Easy Push"** opening system. Internally lit with LED ceiling lights. For improved functionality, the interior space can be modulated using optional movable vertical partitions (no more than 4 pcs)

1



<p>*</p>	<p>System control console between the wall units made of highly cleanable thermoformed ABS/ASA plastic material. Featuring:</p> <ul style="list-style-type: none"> ▪ Electronic control panel (described below) ▪ Prearranged for n° 3 integrated oxygen/air intakes ▪ Medical air system low pressure reading manometer (opt) ▪ Regulation valve for secretion suction system ▪ General oxygen system control valve ▪ Rooftop Oxygen Regulator Valve (OPT) ▪ Recessed compartment for housing up to a maximum of n.3 flow meter columns with anti rotation system ▪ Temperature sensor for rear air conditioning 	
<p>*</p>	<p>Rear control panel for the sanitary compartment with 10" color touch screen panel combined with mechanical push button panel for main services. New concept panel with BACK-UP function. Innovative system that allows you to view and control the front panel services, normally accessible only from the driver's compartment in case of front panel failure. This function reaches its maximum application in case of failure of one of the control panels The rear panel controls the following services:</p> <ul style="list-style-type: none"> - system on/off - sanitary compartment lighting - compartment lighting and furniture - ventilation - air-conditioning - fixed secretion aspiration - sound alarm services - electric door in partition wall - heated compartment - cooled compartment - power inverter 12/220V - room sterilizer <p>Large display (4,3 inches) suitable for displaying the following functions:</p> <ul style="list-style-type: none"> - all services - oxygen system low pressure reading - oxygen system high pressure reading - main battery voltage - secondary battery voltage - 220V external power supply <p>The system described above is equipped with a self-diagnosis system capable of alerting operators/repairers to any malfunction, allowing for immediate resolution of any problems.</p>	<p>1</p> 

FURNITURE (Lower part)

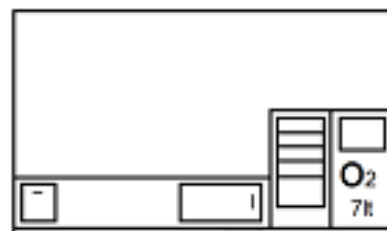

Cylinder column with quick-removal door and transparent plexiglass inspection window

*

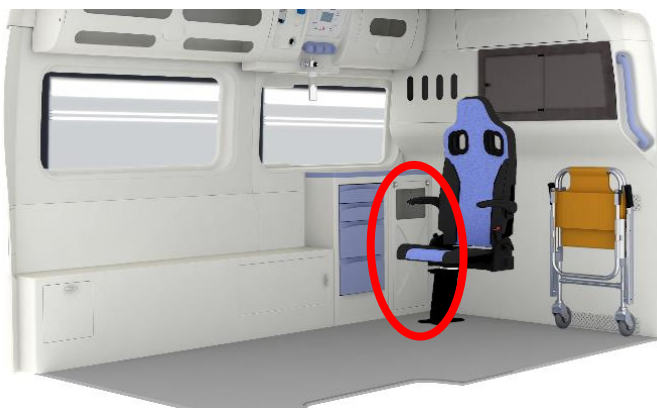

1



Integrated drawer unit with ABS drawers and injection-molded polyurethane fronts, **push/pull opening system** and hold in open position. Drawers available in 2 sizes:

- "small" (LxWxH: 32x20x8, capacity 5 l)
- "large" (LxWxH: 32x20x 19, capacity 12 l).

Possible configurations according to the following scheme:

- 4 "small" drawers and 1 "large" drawer
- 2 "small" drawers and 2 "large" drawers

*

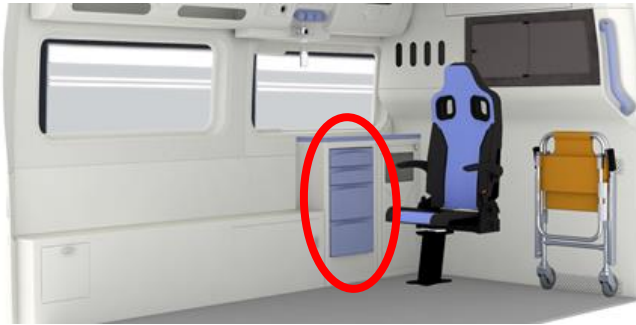

1



Wheel arch cover structure, with compartment closed by sliding door

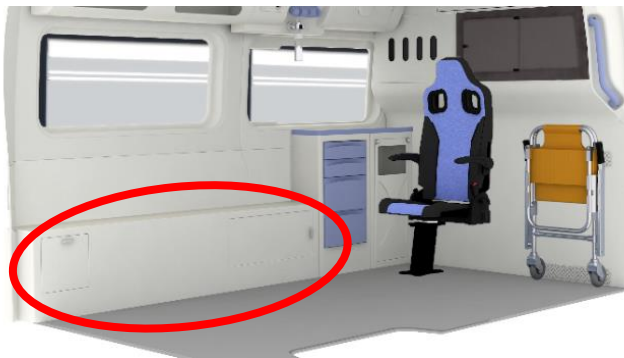

*





1

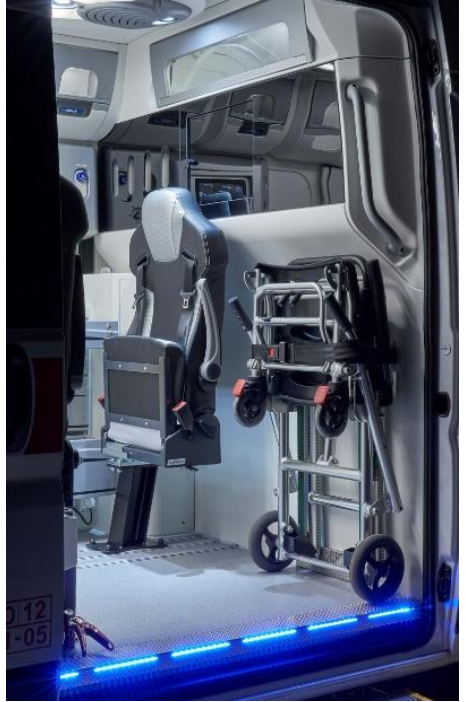

*	<p>TWO-pieces FRS (Fexible Rack System)equipment support structure made of thermoformed plastic material with steel core. Featuring two rows of holes that allow different configurations of bracket mounting through screwing. Supplied with no.1 shelf.</p>	1	
*	Anchor support for portable aspirator	1	Type: <i>to be determined</i>
*	Prearrangement for housing miscellaneous rescue equipment on wheel arch cabinet with strap	1	

3.5 RIGHT SIDE	Qty	Specifications/Notes
WALL CABINETS, COMPARTMENTS AND FURNITURE		
*	<p>Wall cabinet (L = 130 cm) located in the under-roof on the right wall, after the sliding door. Made of white thermoformed high cleanable plastic ABS /ASA, with lower containment edge with windows in transparent plexiglass, completely rounded and shock-absorbing. Doors with "Easy Push" opening system. Internally lit with LED ceiling lights. For improved functionality, the interior space can be modulated using optional movable vertical partitions (no more than 4 pcs)</p> 	<p>1</p> 
*	<p>No.2 ratchet mounts for housing 2/3 l oxygen cylinders, positioned in the right rear corner.</p>	

3.6 DIVIDING BULKHEAD		Qty	Specifications/Notes
FURNITURE AND COMPARTMENTS			
*	Storage compartment made of ABS/ASA thermoformed high cleanable plastic material obtained in the front under-roof, above the driver's cab, with door made of injection polyurethane, tilting, elevating with gas springs and internally lit by means of a led ceiling light. Capacity 60 L.	1	
*	<p>Space Saver" dividing bulkhead between the driver's compartment and the sanitary compartment made of white ABS/ASA thermoformed plastic material, highly cleanable, with recessed shape in the lower part to grant the maximum space in the sanitary compartment and, at the same time, the maximum possible movement of the driver/passenger seat.</p> <p>Featuring:</p> <ul style="list-style-type: none"> ▪ Partial window with polarized safety glass ▪ N. 1 window with sliding glass ▪ No. 4 glove compartments (boxes replaceable from the driver's cab) 	-	
SUPPORT AND HOUSING STRUCTURES			

*	Housing for evacuation chair with castor base, polyurethane protective band and adjustable restraint straps	1	
---	---	---	---

3.7 SEATING	Qty	Specifications/Notes
STRETCHER HEAD SEAT (OPPOSITE TO THE DIRECTION OF TRAVEL)		
*	<p>Seat mod. TAF LINER (M1 Approval) housed in stretcher head (opposite to the direction of travel), comes on high-strength steel legs, with "silver Grey" lightened structure.</p> <p>Single-seater consisting of foldable seat with ultra-low profile and anti-vibration return springs, 160° reclining backrest for "long-distance" use; headrest integrated with the backrest with increased padding; double liftable armrests on left and right sides of the backrest, two-tone shades characterized by easily washable and anti-allergic surface; double 3-point pre-tensioned belts with possibility of "cross restraint" by means of two receptors on seat sides; play-restoring swivel base with 45-degree step rotation for easy availability on the part of the doctor and crew. High-strength 2-color black / carbon Grey covering, class 1 and resistant to even aggressive detergents and disinfectants.</p>	<p>1</p> 
SEATS BESIDE THE STRETCHER (IN THE TRAVEL DIRECTION)		

Pair of seats mod. **TAF LINER** on **EASY MOVE** base , **high-comfort**, with liftable armrests, integrated headrest, **3-point** safety belt with retractor, foldable and swiveling seat. Positioned in the travel direction on the right of the stretcher



*



SEATS FOLDED IN DRIVING DIRECTION



SEAT FRONT OF STRECHER

1



3.8 VARIOUS FITTINGS OF THE SANITARY COMPARTMENT



Qty

Specifications/Notes

*	Vertical grab bar, on the side of the sliding door, made of iron core covered with non-slip injection rubber material	1		
*	Universal storage support for No.3 personal protective helmets on left rear door.	1		

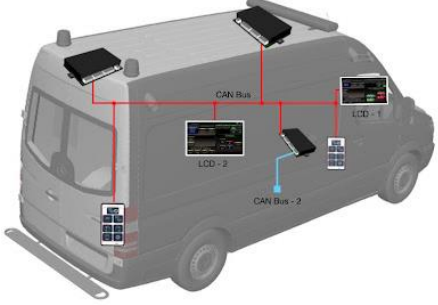
4. INSTALLATIONS

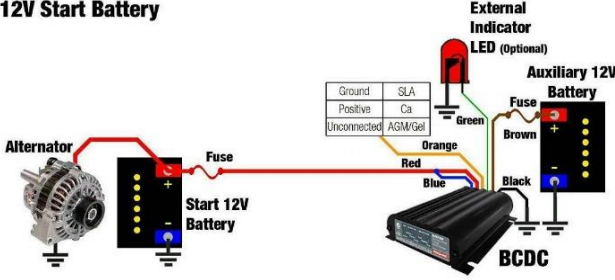
4.1 ELECTRICAL INSTALLATIONS	Qty	Specifications/Notes
<p>POWER CAN-BUS electrical system with the following characteristics:</p> <p><u>Fault Tolerant CAN-BUS:</u></p> <ul style="list-style-type: none"> Increased resistance for the communication bus: even in case of deteriorated wiring, communications are guaranteed. <p><u>Fault Tolerant system:</u></p> <ul style="list-style-type: none"> Redundancy of system controllers with recovery method upon fault removal. <p><u>Fault Tolerant interface:</u></p> <ul style="list-style-type: none"> Possibility of interchange between front and rear display to control the system even in case of failure of the other interface, as well as facilitating in case of needing remote controls. <p><u>Minimum 6 control units for load actuation:</u></p> <ul style="list-style-type: none"> The splitting of the users ensures a higher reliability level as well as better rationalization of the ambulance system. <p>Touch Screen interface.</p> <p><u>Realization of vehicle lighting and signaling completely with LED technology:</u></p> <ul style="list-style-type: none"> Increased energy efficiency and longer service life of the lighting units. <p><u>Complete realization of load control through MosFet technology with automotive protection degree:</u></p> <ul style="list-style-type: none"> By limiting the number of fuses as much as possible and removing relay solutions altogether, a longer equipment life is guaranteed <p><u>System diagnosis:</u></p> <ul style="list-style-type: none"> All system devices are equipped with independent diagnosis/protection control. The control panels (displays) provide feedback for each malfunction, informing the user of the fault and guiding the service centre to resolve the malfunction. <p><u>System security:</u></p> <ul style="list-style-type: none"> All system devices are equipped with protection control. <p>The protection system limits the consumption of some large users (air conditioning, 220v sockets) if the vehicle is switched off or with the engine idling, even to the point of switching off the system if it is left on with the vehicle switched off</p>	<p>1</p>	

*	<p>Electrical socket panel consisting of:</p> <ul style="list-style-type: none"> N. 4 DIN 12V/16A sockets (Jack type) N. 1 Schuko socket 220V/16A with voltage indicator light, powered by Inverter No. 1 industrial-type electrical outlet 2P 12V/16A, purple color, for neonatal incubator 12V current indicator light 220V current indicator light <p>Standard Setup for a 12V Start Battery</p> 	1	
*	Additional service battery for the sanitary compartment, AGM Start-Stop Plus 100 Ah , with high resistance to deep discharge.	1	
*	External socket Mod. SCAME for 220V mains connection equipped with closing door, pins protected by internal barrier, automotive type, approved for vehicle recharging according to IEC/EN 61851-1. This type of socket inhibits vehicle starting even if there is no 220V voltage	1	
*	12/220-volt power inverter, which can be switched on and off from the control panel in the sanitary compartment, dedicated design and architecture for ambulance use (not commercial inverter) , high strength, CE compliance, with the following features: <ul style="list-style-type: none"> Guaranteed maximum deliverable power: 1700 watts Starting power: 2550 watts Wave: true sine wave Self-protection device 	1	
*	System for emergency starting of vehicle from service battery in sanitary compartment, switchable from main control panel	1	

4.2 AIR CONDITIONING, VENTILATION AND STERILIZATION		Qty	Specifications/Notes
*	The air-mixing ventilation system with centrifugal fan provides the possibility of continuous recirculation of air into the sanitary compartment every 3 minutes independently of the temperature settings of the air conditioner. The roof fan/aspirator has 7 different speeds partialized by the CAN system with a very low noise level 65 dB(A). Maximum flow rate in ventilation 420 m3/h. Maximum aspiration flow rate 400 m3/h. An external air lock and recirculation function is standard in all setup versions	1	

*	<p>The new air conditioning system in the sanitary compartment is independent from the vehicle's original system, the hot and cold air inlet circuits are separate for greater efficiency, and the temperature can be set from both the front and rear touch-screen panels.</p> <p>The heating unit, with a capacity of 450 m3/h, is inside the equipped column on the left side and feeds hot air through a dedicated grille.</p> <p>The evaporator of the refrigeration unit, with a capacity of 900 m3/h, is located on the roof at the rear of the vehicle and feeds cold air through the No. 8 vents located at the pavilion.</p> <p>This new location has many advantages: greater thermal efficiency, more spacious blanket compartment, quieter driver's cab, and the evaporator easily accessible for maintenance.</p>	1	
---	---	---	--

4.3 OXYGEN - SUCTION - AIR SYSTEMS	Qty	Specifications/Notes
------------------------------------	-----	----------------------

OXYGEN THERAPY		
----------------	--	--

*	<p>Centralized oxygen therapy system with analog reading pressure gauge and automatic full/empty cylinder exchanger, certified EN 1789 (93/42 CE), made with piping according to law and high-strength materials. System consisting of:</p> <ul style="list-style-type: none"> ▪ 2-socket distribution ramp to UNI standard ▪ 2 precision pressure reducers equipped with pressure gauges ▪ 1 type 0-1 low pressure circuit opening/closing tap (open/closed) ▪ 1 flow meter with humidifier jar, with 0-30 l/min flow adjustment connected to the additional outlet 	1	
---	---	---	--

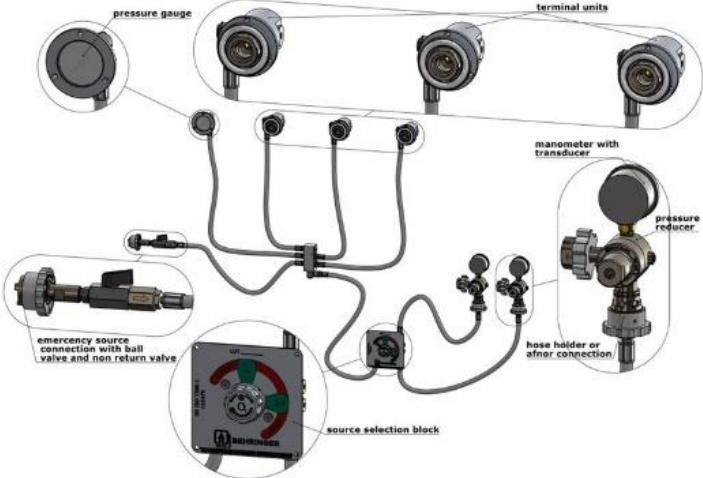
*	<p>Roof drop medical oxygen delivery point with 0-25 l/min flow regulator</p> 	1	
---	---	---	--

SECRETION SUCTION		
*	<p>Fixed secretes suction system , OB 500, suction power 30 l/min, CE certified, complete with:</p> <ul style="list-style-type: none"> ▪ vacuum regulating valve from 0 to 1000 Mbar ▪ 1000 ml secretion collection jar, for disposable bags 	1



4.4 RADIO EQUIPMENT		Qty	Specifications/Notes
*	CARBON rod ¼ wave antenna - VHF range 140-175 MHz	1	
*	STEEL rod ¼-wave antenna for UHF range 140-175 MHz	1	
*	GPS range antenna	1	

5. SANITARY EQUIPMENTS

5.1 STRETCHERS AND STRETCHER SUPPORTS		Qty	Specifications/Notes
STRETCHER SUPPORT			
*	<p>Translating stand for Stem TR96-SC stretcher, foot pedal operation, mechanical movement, loading slide, 1 compartment underneath for holding spine board and scoop stretcher</p>  <p>The image shows a long, silver metal translating stand for a stretcher. It has a foot pedal on the right side. A blue double-headed arrow indicates a length of 300 mm. A small inset box shows a technical drawing of the stand with dimensions: 2020x630 mm and a height of 168 mm, and a weight of 51 kg.</p>	1	MODU

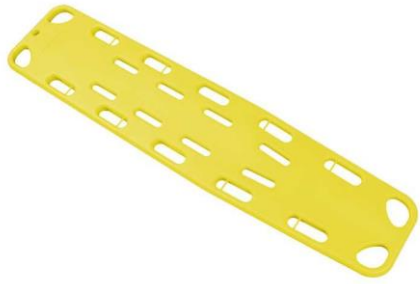

MAIN STRETCHER		
<p>"FROG" yellow self loading stretcher with trendelenburg Made of welded stainless steel powder coated, this is a really strong and reliable device. The Ø 200 mm wheels (2 fixed with brake and 2 rotating with self-centring system) are made of soft material that allows high comfort level to the patient. This model of stretcher has trendelenburg position to 0° from 20° too.</p> <p>* - Rigid platform made of reinforced thermoplastic material. - Reclining backrest 0°- 80°, operated by a gas piston, can be locked in any position. - Folding sides. - Vertical legs protected by plastic buffers. - Casters are self-centering so that the stretcher can be positioned in the ambulance without them having to be turned manually. - Front trolley can be lowered to reduce overall dimensions of the stretcher.</p>	1	
<p>"MEBER NILIX 9050 Spine board made of high-strength plastic material with PINS. Complete with : Jelly Cod.629 universal head restraint and Spider Cod.690 immobilization belts Capacity 150kg</p> <p>*</p>	1	

5.2 TRAUMATOLOGY - IMMOBILIZATION		Qty	Specifications/Notes
* SPENCER SED Green-colored extrication device complete with bag. Code SR00111 B"	1		
* MEBER ANTARES 854 Set of No. PCS 4 bivalve rigid cervical collars with case. Includes code 842 (Pediatric)-844 (Sout)-846 (Standard)-848 (Medium)"	4		
* MEBER NEOFIX 417 Set no. 5 pcs. neoprene fixo splints with case. Sizes: leg, arm, forearm, wrist and ankle/elbow."	5		

5.3 ELECTROMEDICAL EQUIPMENT		Qty	Specifications/Notes

5.4 MISCELLANEOUS MEDICAL SUPPLIES		Qty	Specifications/Notes
GIMA SPHYGMOMANOMETER Wall-mounted sphygmomanometer."	1		
SPENCER MATCH 3 Multipurpose scissors complete with plastic stand. Chrome color with black handle. Code GD02060 C"	1		

"SPENCER PRO CAP Protective safety helmet made of low-pressure, injection-molded polyethylene. White color. Code DR20002 K"	3		
BOSCAROL ATLS MODULE 2 Red rescue backpack complete with No. 4 colorful inner pouches. Code BOR81146 N"	1		
BOSCAROL TRAUMA BAG 10 PEDIATRIC Pediatric rescue bag made of tear-resistant and waterproof nylon. Sold empty. Code BOR89040PR"	1		
SPENCER HIRVIN High-strength, double-coated nylon patient transport sheet with 6 yellow handles. Code QM40101 A"	1		

5.5 UTILITY MATERIAL		Qty	Specifications/Notes
*	4 kg fire extinguisher housed in the sanitary compartment	1	
*	4 kg fire extinguisher housed in the driver's cab	1	